

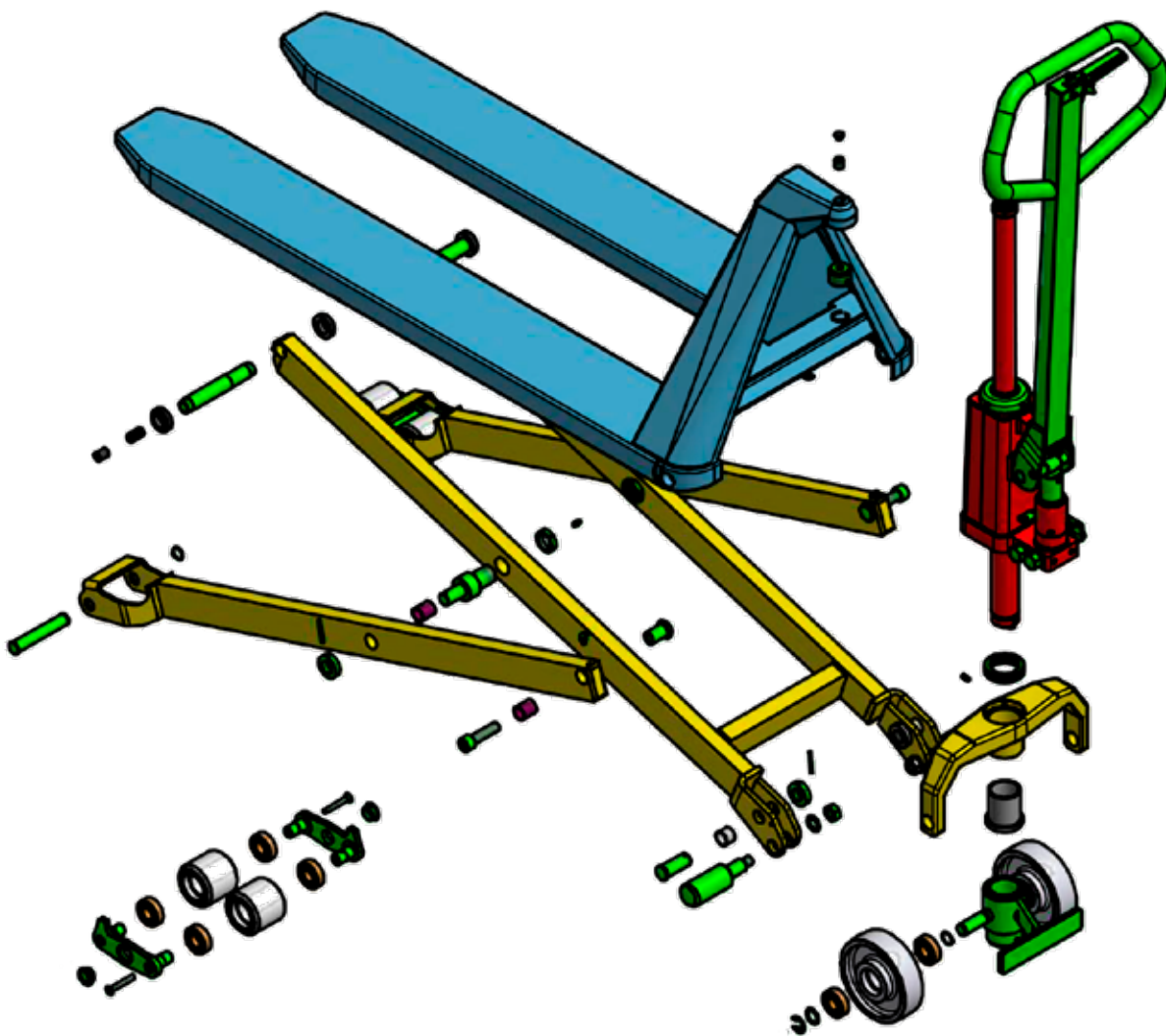







HL 1004 INOX

| | | | | |
|---|---------------------------------------|--|---|---|
| Syrefast stål | Acid-resistant steel | Säurebeständiger Stahl | Inox - Anti acides | EN 1.4404 (AISI 316L) EN 1.4460 (AISI 329) |
| Rustfrit stål | Stainless steel | Edelstahl | Inox | EN 1.4305 (AISI 303) EN 1.4301 (AISI 304) |
| Zink/Jern sort passivering med sealer | Zinc-iron black passivating + sealer | Zink/Eisen schwarz passiviert + Versiegelung | Zinc/traitement de surface polymère noir | Fe//ZnFeX//Fn//T2 |
| Zink/Jern silver passivering med sealer | Zinc-iron silver passivating + sealer | Zink/Eisen silber passiviert + Versiegelung | Zinc/traitement de surface polymère argenté | Fe//ZnFeX//Cn//T2 |
| Gummitættnede lejer | Rubber sealed bearings | Lager m/Gummidichtung | Roulements étanches | |
| Bronze | Bronze | Bronze | Bronze | |
| Malet 130-150 µm | Painted 130-150 µm | Gemalt 130-150 µm | Peinture 130-150 µm | |



HL 1004 INOX

| | | | | | |
|---|---|---------------------------------------|--|---|---|
|  | Syrefast stål | Acid-resistant steel | Säurebeständiger Stahl | Inox - Anti acides | EN 1.4404 (AISI 316L) EN 1.4460 (AISI 329) |
|  | Rustfrit stål | Stainless steel | Edelstahl | Inox | EN 1.4305 (AISI 303) EN 1.4301 (AISI 304) |
|  | Zink/Jern sort passivering med sealer | Zinc-iron black passivating + sealer | Zink/Eisen schwarz passiviert + Versiegelung | Zinc/traitement de surface polymère noir | Fe//ZnFeX//Fn//T2 |
|  | Zink/Jern silver passivering med sealer | Zinc-iron silver passivating + sealer | Zink/Eisen silber passiviert + Versiegelung | Zinc/traitement de surface polymère argenté | Fe//ZnFeX//Cn//T2 |
|  | Gummitættnede lejer | Rubber sealed bearings | Lager m/Gummidichtung | Roulements étanches | |
|  | Bronze | Bronze | Bronze | Bronze | |
|  | Malet 130-150 µm | Painted 130-150 µm | Gemalt 130-150 µm | Peinture 130-150 µm | |

